

## ACCESSORIES

### Car Adapter

Enables you to re-charge your battery with your vehicle's electrical system.



Part No. 900507

### Battery Cell

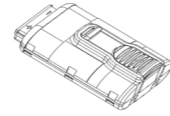

Part No. 018880

### Battery Charger

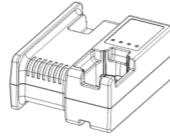

Part No. 018881 (EU)  
018882 (UK)

### Cable

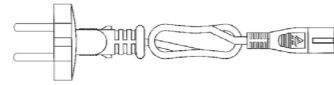

Part No. 018885 (EU)  
018886 (UK)

### No-Mar Tip - 3 Pk. - Hard Tip No-Mar Tip - 3 Pk. - Soft Tip

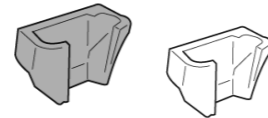

Part No. 901048  
Part No. 901067

### Special Panelling No-Mar Tip

Position the nailer for a 45 degree shot

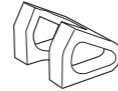

Part No. 012027

### 9/64" Hex Key

For cleaning tool

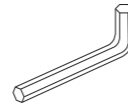

Part No. 900736

### Safety Glasses



Part No. 014121

### Paslode Intensive Tool Cleaner 300 ml

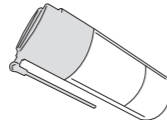

Part No. 115251

### Paslode Impulse Lubricating Oil

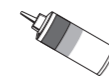

Part No. 401482

### Carrying Case



Part No. 014975

### Cleaning Kit

Contains all the necessary to clean any Impulse tool

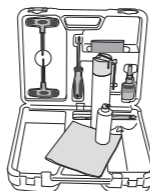

Part No. 013060

# Paslode®

## Impulse®

Part No. 013332 (EU)  
Part No. 013333 (UK)



## IM50 F18 Lithium

### IMPORTANT! DO NOT DESTROY

Always refer to operating and safety instructions (#018909 & #014744) for detailed information on this tool. It is the customer's responsibility to have all operators and service personnel read and understand this information.

## TOOL SCHEMATIC AND PARTS



An Illinois Tool Works Company  
Route de Lyon - BP 104  
F - 26501 Bourg Les Valence - Cedex France

018908-1  
07/13

1	013715	1	Grill black	61	901019	1	Torsion Spring Magazine Latch
* 2	900648	1	Filter	62	900353	1	Pivot Pin
3	901064	4	S.H.C.S. 8-32 x 1-3/8"	63	901014	1	Magazine Latch Release
4	900785	1	Spark Plug Sleeve	64	901061	2	Screw 6-32 x 3/16 BH
5	902011	1	Cap black	66	901013	1	Magazine End Cap
6	901119	1	Retaining Ring	67	013671	1	Warning Label Top
8	901382	1	Fan Motor Assembly	68	902416	1	Depth of drive Indicator Label
9	900785	1	Insulator	69	404922	2	Battery Contact Pad
*13	401356	1	Motor Sleeve	70	901095	1	Switch Side Assembly
14	900714	1	Spark Plug Assembly	71	900792	2	Shoulder screw 8-32 x 15/82"
15	900674	1	Wire Clip	73	901084	1	Magazine Wear Strip Assembly
16	900697	1	Stem Adapter	▲ 74	900660	2	Screw 10-32 x 3/8"
■ 17	405140	4	Scfew 8-32 x 7/16" (red)	75	901062	1	Screw 6-32 x 1/8"
18	900596	1	Screw, Sem 8-32 x 7/16"	76	901012	1	Magazine Cover
19	900739	1	Cylinder Head Circuit Board Ass.	77	901015	1	Follower
20	900605	1	Cylinder Head	78	901018	1	Magazine Pin
21	900612	4	Seal Ring	79	901055	1	O-ring
22	900709	1	Fan Assembly	80	901052	1	Spring Cover
23	900700	1	Air Dam	81	901016	1	Constant Force Spring
24	900729	1	Combustion Chamber Assembly	82	901017	1	Spool Spring
25	900746	2	Screw 8-32 x 7/16 phtx	84	903702	1	Handle Left
26	901038	1	Spring	85	903701	1	Handle Right
27	901037	1	Yoke	86	901066	4	Screw- Plastite
28	901039	1	Yoke Support	87	900703	1	Handle Bracket
31	900734	1	Roll Pin	88	900755	1	Bushing Actuator
32	902437	1	Knob W	89	900788	1	Actuator Assembly
34	901009	1	Latch Cover Quick Clear	90	404433	1	Pin Actuator
35	900685	1	Spring Pin	91	900765	1	Spark Plug Wire Assembly
36	901005	1	Latch Clip	92	904562	1	Fan Wire Assembly
37	901049	1	Spring Pin	93	902439	1	Molded Circuit Assembly
38	901006	1	Spring Clip Assembly	*94	901021	1	Piston Bumper
39	901002	1	Front Plate	95	901078	1	Piston Assembly
40	901048	1	Probe Tip	96	901040	1	Piston Ring
41	901007	1	Probe	97	901036	1	Retaining Ring
42	901026	2	Screw 10-24 x .75	98	901044	1	Soft Grip
43	901003	1	Black Plate	99	902440	1	Electronic Spark Unit
44	901025	1	Support Pin	100	900662	1	ESU Power Wire Assembly
45	901004	1	Front Plate Support	101	901045	1	Trigger
46	901081	1	Sleeve Assembly	102	900608	1	Trigger Spring Bushing
47	900616	1	O-Ring	103	901047	1	Trigger Pin
48	901089	1	Exhaust Baffle	104	901053	1	Trigger Spring
49	900665	1	Reed Plate	105	404702	2	Screw 6-32 x 3/8"
50	900664	1	Reed Valve	106	900629	1	High Tension Clip
51	900609	1	Muffler	→107	903003	1	Contact Positive
52	900668	1	Muffler Cover	→108	903004	1	Contact Negative
54	901059	1	Front Channel	109	902434	1	Nut-Utility Hook
55	900598	2	Screw 10-32 x 5/16" (red)	110	902433	1	Button
56	018926	1	Label, Li-Ion IM50 F18	111	902431	1	Block-Utility Hook
57	018929	1	Nameplate	112	902432	1	Spring
58	404385	1	Light Pipe	113	902435	1	Stop Utility Hook
59	018923	1	Handles Label assembly	114	902430	1	Utility Hook

\* Indicates normal wear items  
 → Denotes Change  
 ■ Grease Part No. 900767 to Threads.  
 ▲ Apply Loctite RC-620 (Green)

**SAFETY INSTRUCTIONS**  
**WEAR EYE AND HEARING PROTECTION**



Always wear eye and hearing protection when operating a nail tool.

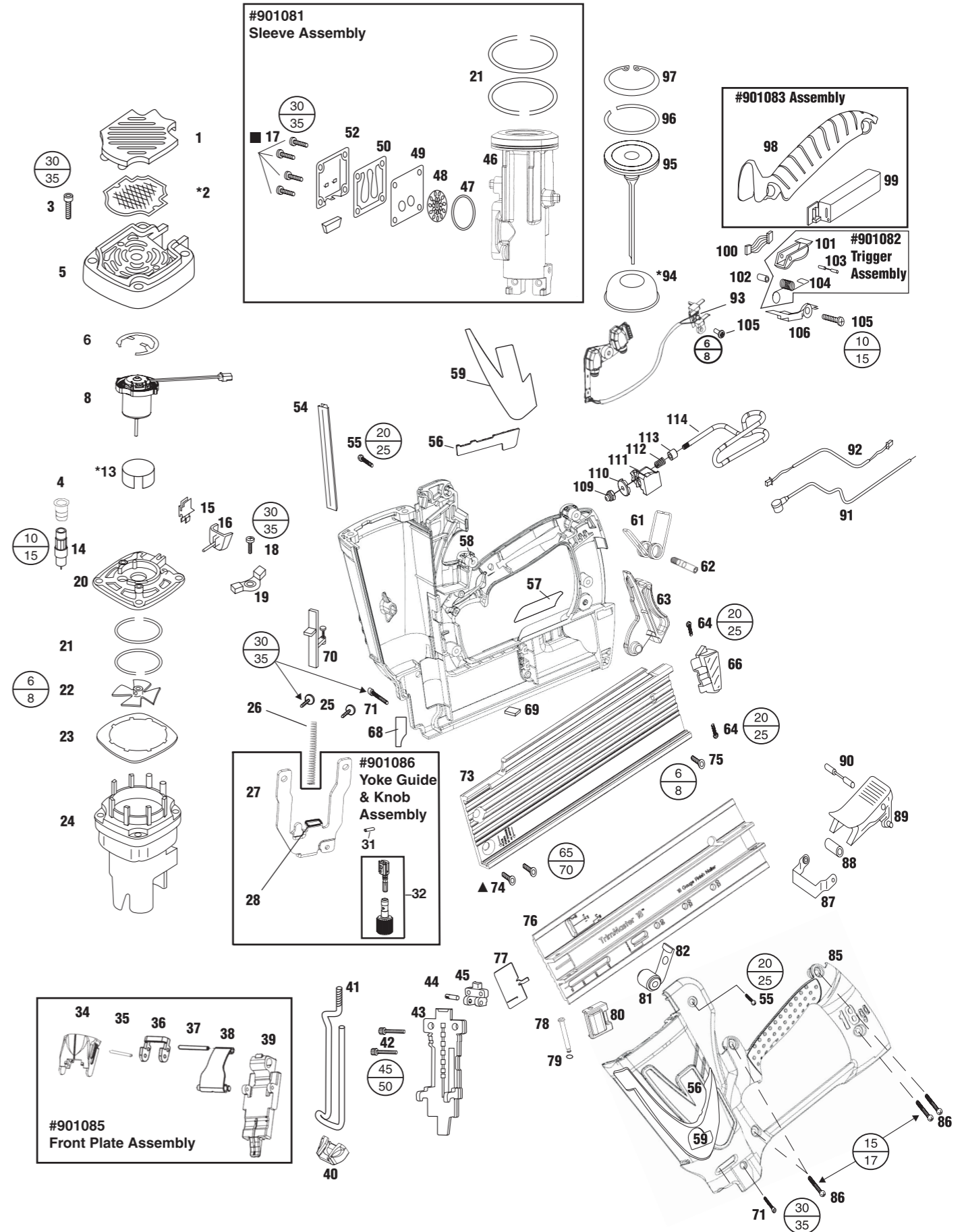

**TORQUE VALUES**

MIN	IN.LBS
MAX	

**CAUTION**  
 All parts must be periodically inspected and replaced if worn or broken. Failure to do this can affect the tool's operation and present a safety hazard.